

| REVISIONS | | | |
|-----------|-------|------------|--|
| Rev. | Drawn | Date | Revisions |
| | GBC | 9/25/2020 | Adapted AC schematic to DC version |
| | GBC | 10/6/2020 | Added missing motor fuse |
| | GBC | 11/24/2020 | <ul style="list-style-type: none"> Click add-on C1 to 24V Minarik 9 & 5 tied to Click PLC Y2 Click PLC X4 to COM Minarik 4 & 6 shorted |

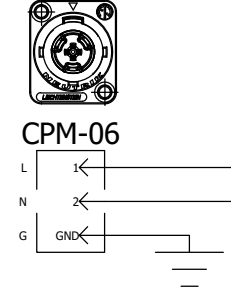

24VDC Deck Chief
Schematic
Scale: N/A
Drawn on: 9/25/2020
Drawn By: GBC

X1
NAC3MPX
True1 Male Panel Mount



X2
MENCOM CQF-12
21mm x 21mm (3A)
12P 10A FEMALE

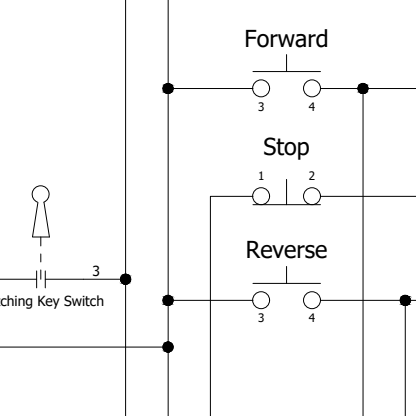
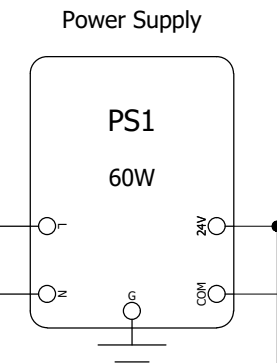
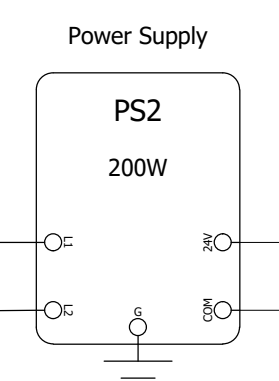
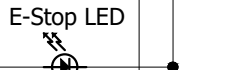
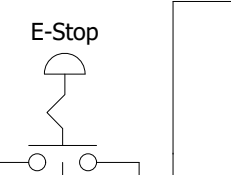
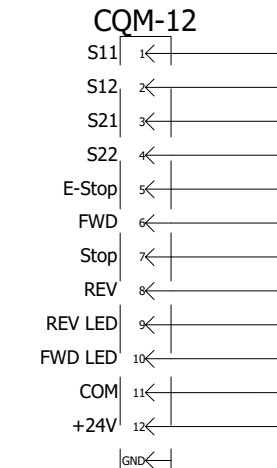
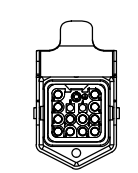

Constant 24VDC

COM
Switched 24VDC

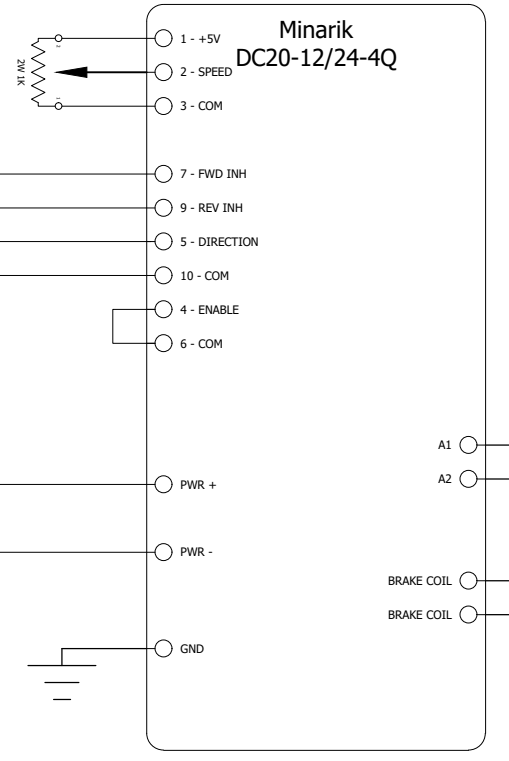
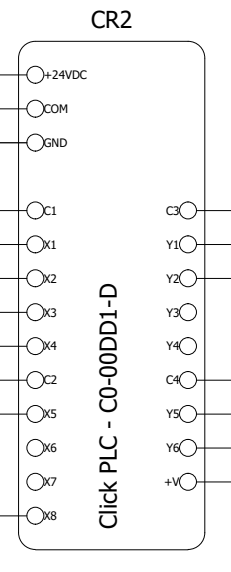
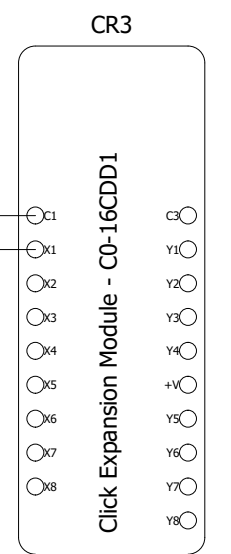

F1
8A 5mm x 20mm FAST-ACTING

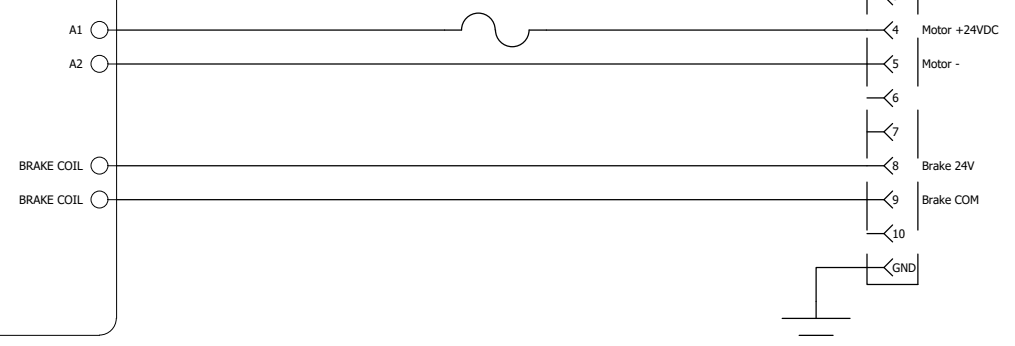

X3
Mencom CCEF-10
57mm x 27mm (10B)
10P 35A FEMALE 230V

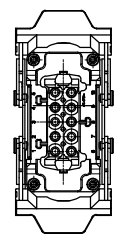

X4
MENCOM CDDF-24
44mm x 27mm (6B)
24P 10A FEMALE

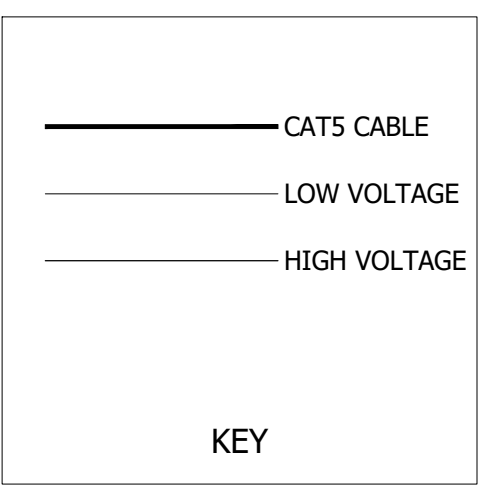
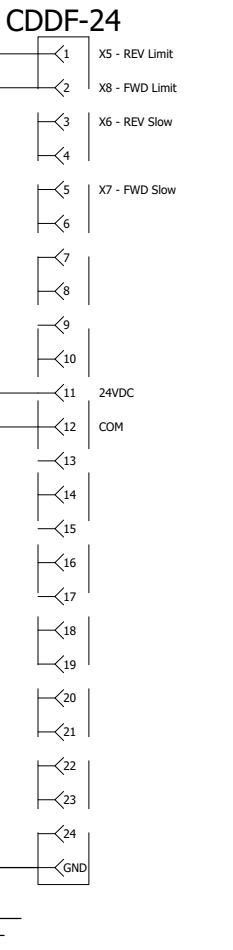
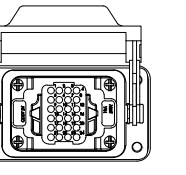

Terminator
DECK CHIEF REMOTE
MENCOM CQM-12
21mm x 21mm (3A)
12P 10A MALE

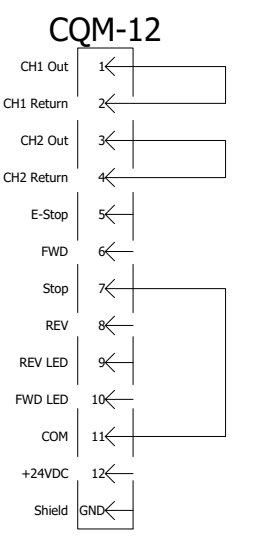
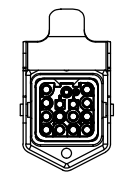

Remote
DECK CHIEF REMOTE
MENCOM CQM-12
21mm x 21mm (3A)
12P 10A MALE

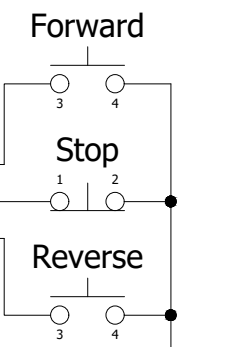
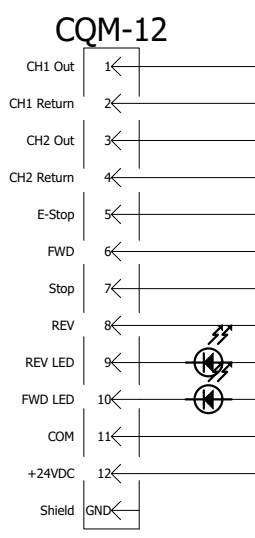
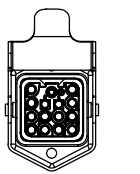

- 1 - Brown/Green
- 2 - White/Green
- 3 - White/Yellow
- 4 - Purple
- 5 - Brown
- 6 - White
- 7 - Gray
- 8 - Yellow
- 9 - Pink
- 10 - Blue
- 11 - Black
- 12 - Red

tolerances:
% : ±1/16"
.xx : ±0.010
.xxx : ±0.003
the information contained in the drawing is the property of creative conners inc.